

Article number: 20958470

Description: E+G Levelling foot
GN 343.3-60-M12-G

Measures

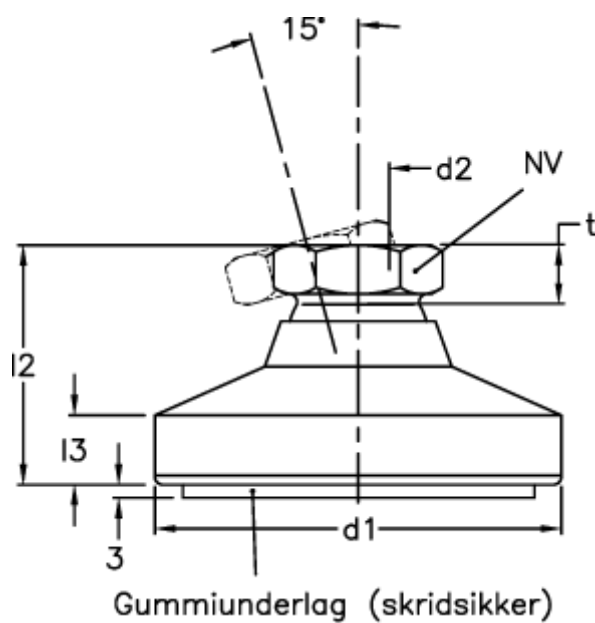

$d1$	= 60
$d2$	= M12
$l2$	= 35.5
$l3$	= 8.5
NV	= 17.0
Static load (N)	= 14000
t min	= 11.5